

Low Voltage (DC)
 Brush motor **Brushless motor**
 Miniature screw Precision screw Machine screw
 2.6 - 8.0 mm

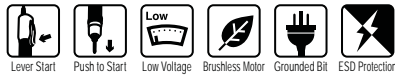

Delvo Brushless Type

A Series (Low Voltage Type) Model DLV30A/45A/70A



Features

Eco-friendly electric screwdrivers with built-in brushless motors in a low voltage (DC) profile

- Torque range from 0.4 to 7.0 Nm
- Speed range from 650 to 2000 min⁻¹
- Both the Lever Start and Push to Start type models are available
- Equipped with a torque adjustment ring cover
- Design conforms to the RoHS Directive and thus appeals to the environmentally conscious user
- Easily detachable Pistol Grip DLW2300 (TD00335) comes with the unit as a standard accessory (DLV45A/70A)
- ESD (electrostatic discharge) protection structure

Specifications

		Low Speed	Standard	High Speed	Low Speed	Standard	Low Speed	
Model	Bit	DLV30A06L-AY : K	DLV30A12L-AY : K	DLV30A20L-AY : K	DLV45A06L-AY : K	DLV45A12L-AY : K	DLV70A06L-AY : K	
	Lever Start	DLV30A06L-AY : K	DLV30A12L-AY : K	DLV30A20L-AY : K	DLV45A06L-AY : K	DLV45A12L-AY : K	DLV70A06L-AY : K	
Power Source		DEA0151N-AZ or DEA0241N-AZ		DEA0241N-AZ	DEA0151N-AZ or DEA0241N-AZ		DEA0241N-AZ	
Torque Adjustment		Stepless						
Torque (Nm [lbf-in])	Low Torque Spring*1	0.4 - 1.6 [3.5 - 14.2]			2.0 - 4.5 [17.7 - 39.8]		3.8 - 7.0 [33.6 - 62.0]	
	High Torque Spring*2	1.2 - 3.0 [10.6 - 26.6]						
Free Speed (min ⁻¹)		650	1200	2000	650	1200	650	
Power Consumption (W)		44						
Screw Size (mm)	Machine Screw	2.6 - 5.0			4.5 - 6.0		5.0 - 8.0	
	Tapping Screw	2.5 - 4.0			4.0 - 5.0		4.5 - 6.0	
Mass (g [lbs])		690 [1.52]			840 [1.85] (with Pistol Grip)			
Standard Accessories		• Bit NK35 × 2 × 7 × 75 • Suspension Bail • Low Torque Spring • Connection Cord (DLW9073)		• Bit NK35 × 2 × 7 × 75 • Connection Cord (DLW9073) • Suspension Bail • Pistol Grip (DLW2300ESD)				

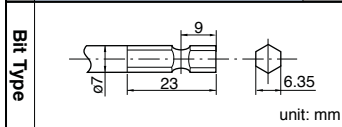

*1: Standard Accessory
 *2: Built-in.

Please contact us for 5 mm bit type.

Power Supply	Model	DEA0151N-AZ	DEA0241N-AZ
Input		100 - 240 V AC, 50/60 Hz, 60 W	
Output		40 V DC	
Maximum Rated Power (W)		150	240
Mass (kg)		0.56	0.9

*The power cord is sold separately. Ask us for the required power cord when ordering.

Torque Diagrams (for reference)

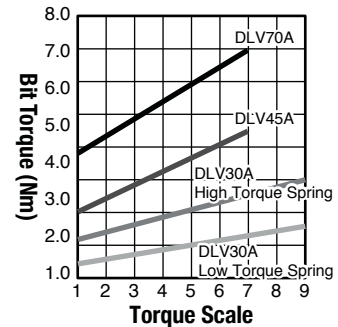

External Dimensions

•DLV30A□P

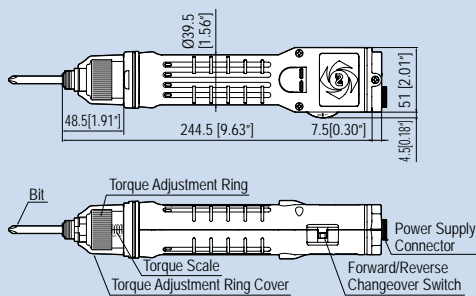

•DLV30A□L

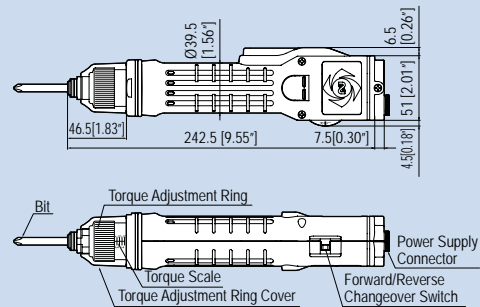

•DLV45A□P/DLV70A□P

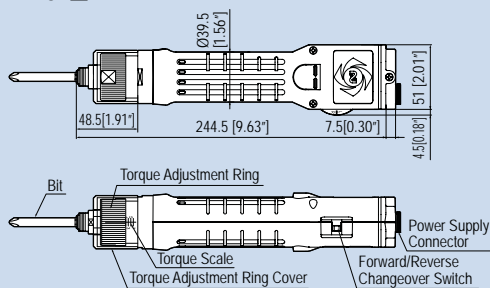

•DLV45A□L/DLV70A□L

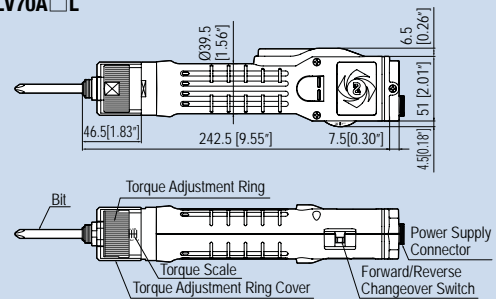

unit: mm [inch]

(See page 12 for external dimensions of power supply DEA0151N-AZ and DEA0241N-AZ)